

ST650(P)



Display size
39"- 75"



Max load
175lb (79kg)

SMARTMOUNT

Universal Tilt Wall Mount

FOR 39" TO 75" DISPLAYS

The SmartMount® Universal Tilt Wall Mount series offers the most versatile installation features and mounting options. Horizontal and vertical adjustment abilities allow for post installation leveling and side-to-side positioning, making it easier than ever to find the perfect TV position. Lock the tilt angle at installation to prevent tampering or moving with the IncreLok™ tilt technology. Security screws provided in the ST650 models deter tampering and theft. The open wall plate design offers total wall access, increasing the electrical and cable management options. The display can now simply be installed by a single person with the Hook-and-Hang™ system. The Easy-Glide™ adaptors hook onto the wall plate for an overall quick, simple, and secure installation.

The ST650's adjustable viewing feature provides 15° of forward tilt and 5° backward tilt, creating the most optimal viewing angle.



Additional Features

- ✓ Universal mount fits displays with mounting patterns up to 742 x 405mm (29.21" W x 15.95" H)
- ✓ Adjustable 15° forward tilt and 5° backward tilt for finding the optimal viewing angle
- ✓ Easy-Grip™ ratcheting handle locks tilt angle into place
- ✓ Included IncreLok™ feature offers fixed tilt lock in 5° increments when used
- ✓ Up to 0.25" (6mm) of vertical adjustment on each universal display adaptor bracket for post-installation leveling and height adjustment fine-tuning
- ✓ Horizontal display adjustment up to 8.00" (203mm) for centering display on wall
- ✓ Mounts to wood studs, concrete, cinder block or metal studs (metal stud accessory required)
- ✓ Includes all necessary wall and display attachment hardware
- ✓ Integrated security options available
- ✓ Design is UL listed and tested to four times stated load capacity

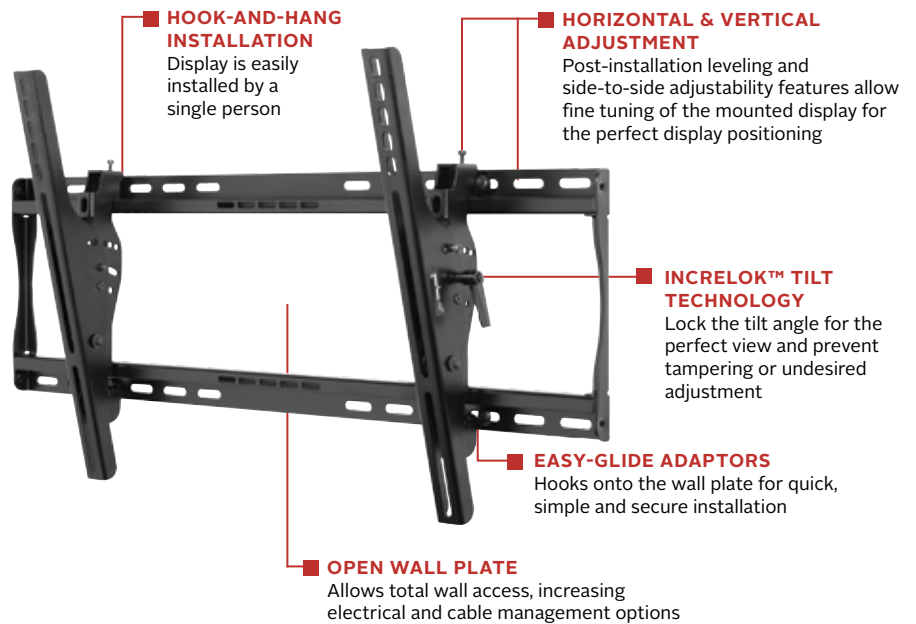

+15°/-5° of tilt for versatile viewing angles



Comes in color packaging with included installation hardware and easy to follow instructions.



Please visit peerless-av.com/en-us/patents for patent information.

info@peerless-av.com
peerless-av.com

peerless-AV®

Model Numbers

WARRANTY: Limited 5-year

ST650P	SmartMount® Universal Tilt Wall Mount for 39" to 75" Displays - standard models
ST650	SmartMount® Universal Tilt Wall Mount for 39" to 75" Displays - security models

Product Specifications

	DIMENSIONS (W x H x D)	PRODUCT WEIGHT	LOAD CAPACITY	FINISH	AVAILABLE COLORS
ST650(P)	31.26" x 16.89" x 2.62"-5.40" (794 x 429 x 67-137mm)	8.15lb (3.70kg)	175lb (79kg)	Scratch resistant fused epoxy	Semi-gloss black

Package Specifications

	PACKAGE SIZE (W x H x D)	PACKAGE SHIP WEIGHT	PACKAGE UPC CODE	PACKAGE CONTENTS	UNITS IN PACKAGE
ST650(P)	33.19" x 2.95" x 10.71" (843 x 75 x 272mm)	10.35lb (4.70kg)	ST650: 735029235941 ST650P: 735029235965	Wall mount, wall and display installation hardware, installation instructions	1

Accessories

ACC415: Metal Stud Fastener Kit

All dimensions = inch (mm)

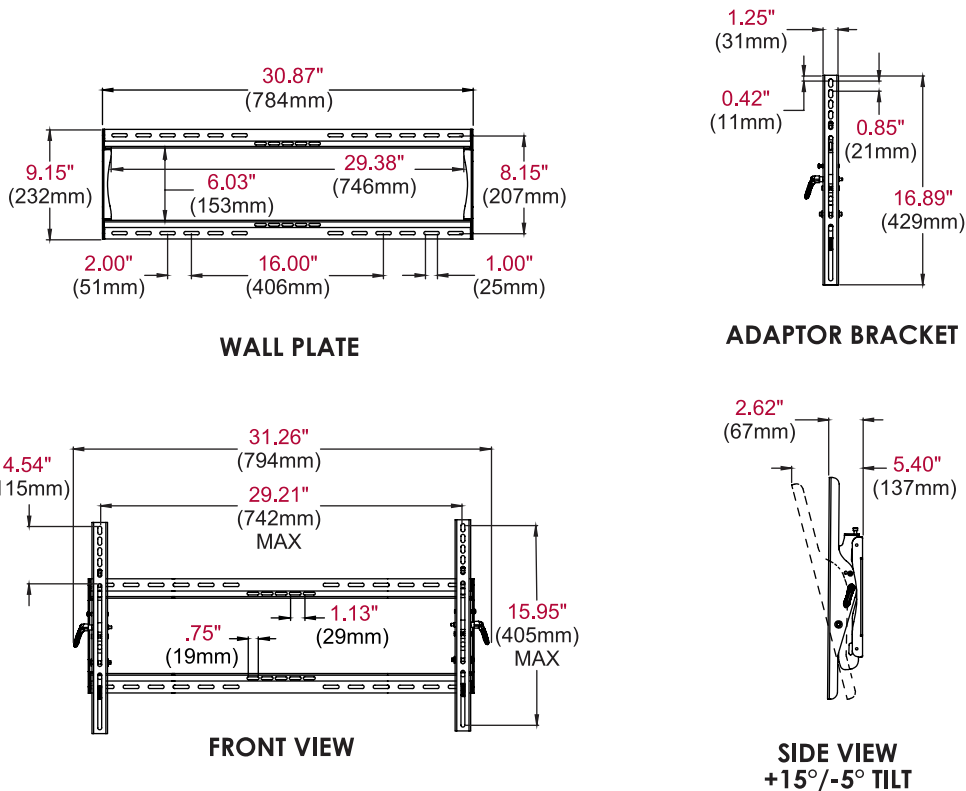

Architect Specifications

The Smartmount® Tilt Wall Mount shall be a Peerless-AV model ST650(P) and shall be located where indicated on the plans. Assembly and installation shall be done according to instructions provided by the manufacturer.

Visit peerless-av.com to see the complete line of AV solutions from Peerless-AV, including outdoor displays, wireless, kiosks, digital audio, display mounts, projector mounts, carts/stands, and a full assortment of accessories.

Peerless-AV
2300 White Oak Circle
Aurora, IL 60502 USA
(800) 865-2112
(630) 375-5100
Fax: (800) 359-6500

Peerless-AV Europe
Unit 3 Watford Interchange
Colonial Way, Watford
Herts, WD24 4WP
United Kingdom
+44 (0) 1923 200100
Fax: +44 (0) 1923 200101

Peerless-AV de México
Ave de las Industrias 413
Parque Industrial Escobedo
Escobedo, N.L.,
Mexico 66050
+52 (81) 8384-8300
Fax: +52 (81) 8384-8360

peerless-AV®

LIT-0594 Rev.4-uk